

Cover Specification

Origin of Materials	100% US Manufactured
Material	HDPE
Mfg. Method	Injection Molding
Weight	.35 lbs. / 155 g
Height	1"
Outside Diameter	10" x 10"
Min Wall Thickness	.065"
Standard Color	White <i>Please inquire about custom colors</i>
Quantity	1265 Units per Pallet (if pails have no middle pallet Double Stacked, 10,800 Units per Truckload) 1200 Units per Pallet (if pails have a middle pallet Double Stacked, 10,120 Units per Truckload)

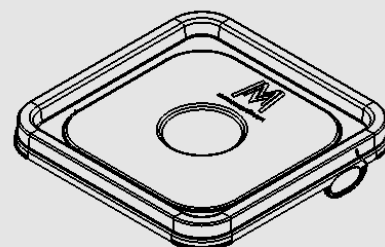

Pail Specification

Origin of Materials	100% US Manufactured
Material	HDPE
Mfg. Method	Injection Molding
Weight	1.35 lbs. / 610 grams
Min. Wall Thickness	.065"
Exterior Height	14-3/4" With Cover 14-7/8"
Top Outside Diameter	10" x 10"
Bottom Outside Diameter	8-1/4" x 8-1/4"
Shipping Quantity	240 Units per Pallet (No Middle Pallet Double Stacked) 10,800 Units per Truckload 220 Units per Pallet (With Middle Pallet Double Stacked) 10,120 Units per Truckload
Standard Color	White <i>Please inquire about custom colors</i>
Decoration	In Mold Labeling (IML)
Top Load Rating	300 lbs.

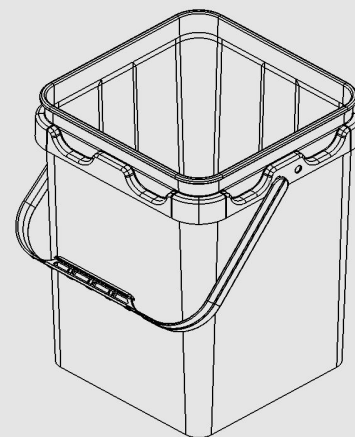

Pack Specifications For Cover

Shipped with Double Stacked

Pallets, No Middle Pallet

- 1265 lids per pallet
- 20 Stacks x 63 high
- Lid Material is PP

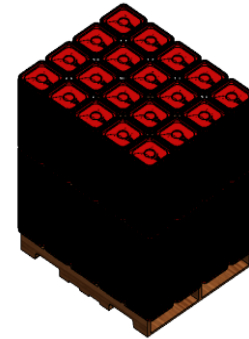
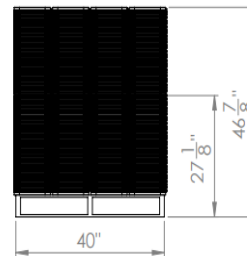
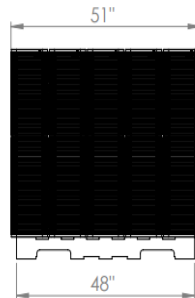
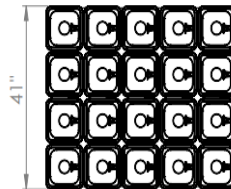

Pack Specifications For
Cover Shipped with
Double Stacked Pallets,
With Middle Pallet

- 1200 lids per pallet
- 20 Stacks x 60 high
- Lid Material is PP

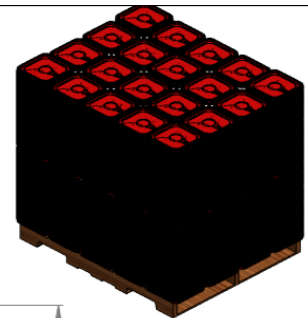
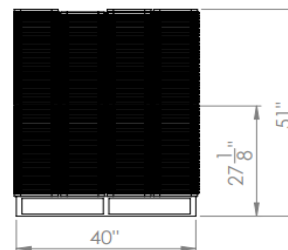
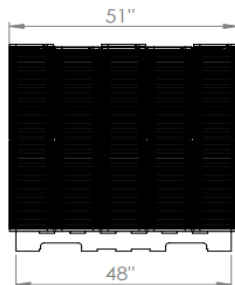
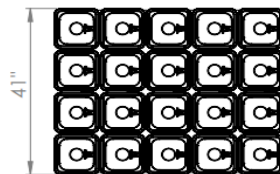

Pack Specifications For Pail

Shipped with Double Stacked

Pallets, No Middle Pallet

- 240 pails per pallet
- 20 Stacks x 12 high
- Pail Material is PP

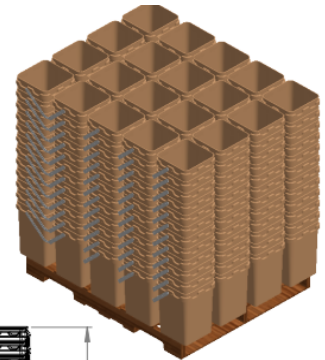
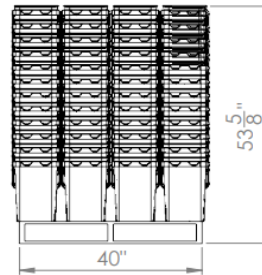
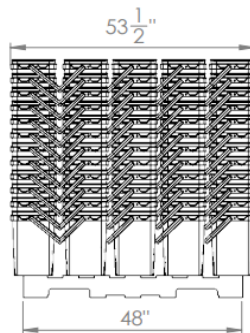
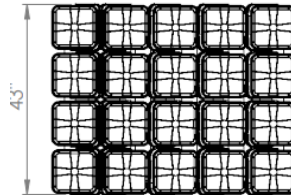

Pack Specifications For Pail Shipped with Double Stacked Pallets, With Middle Pallet

- 220 pails per pallet
- 20 Stacks x 11 high
- Pail Material is PP

